

Van Cleef & Arpels

Charms

Case size guide

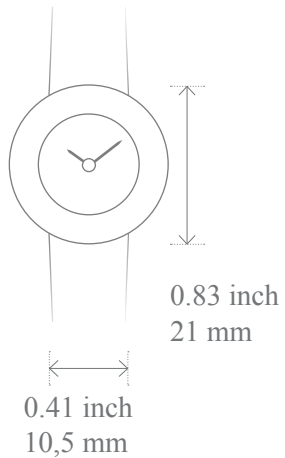

Sweet Charms

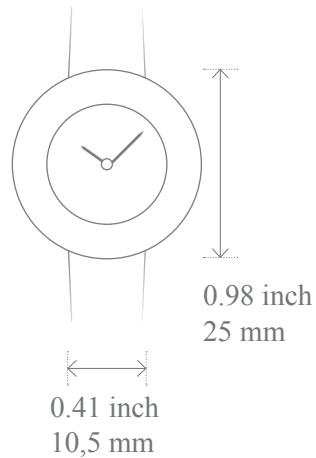

Charms 25mm

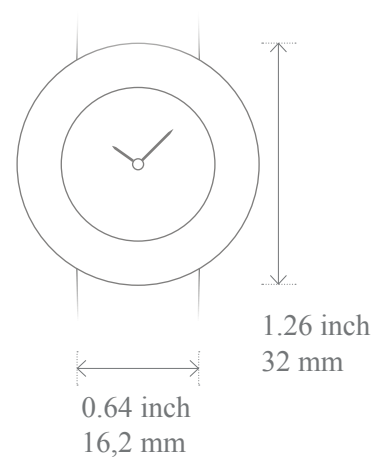

Charms 32mm

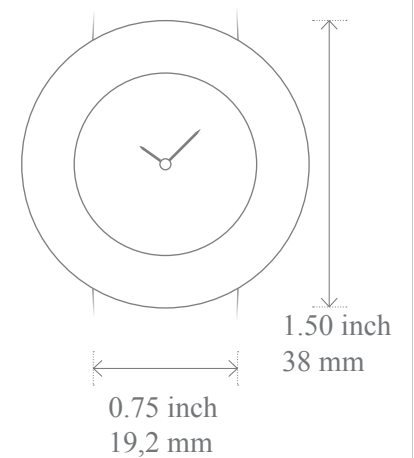

Charms 38mm

Print in actual size to see the real dimension of the case

Please note that the size guide is an indicative tool. We recommend you to visit one of our Boutiques to try the watches on in order to define which one fit you best.

© Van Cleef & Arpels-2018 All rights reserved