

Van Cleef & Arpels

Movimento a quartzo com coroa

1. Leitura da hora

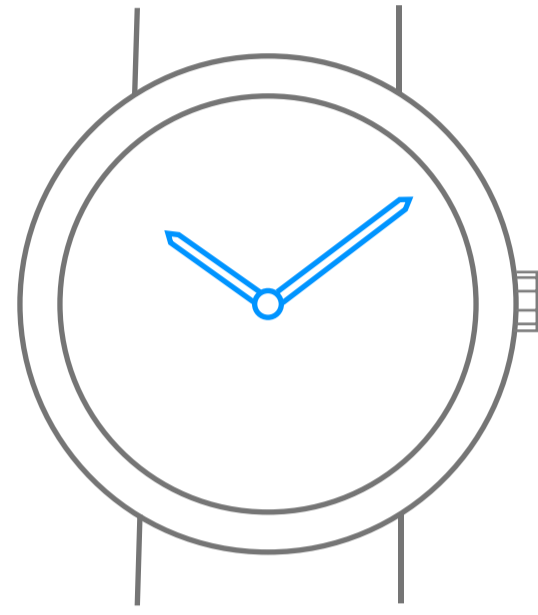

10 : 10

2. Ajuste da hora

1.

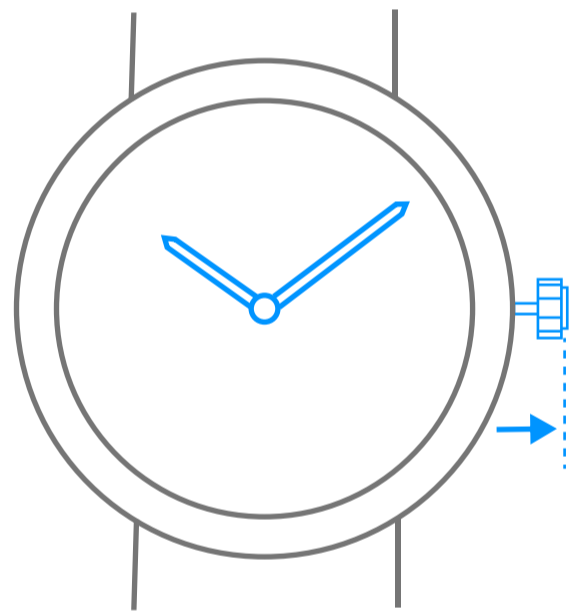

10 : 10

2.

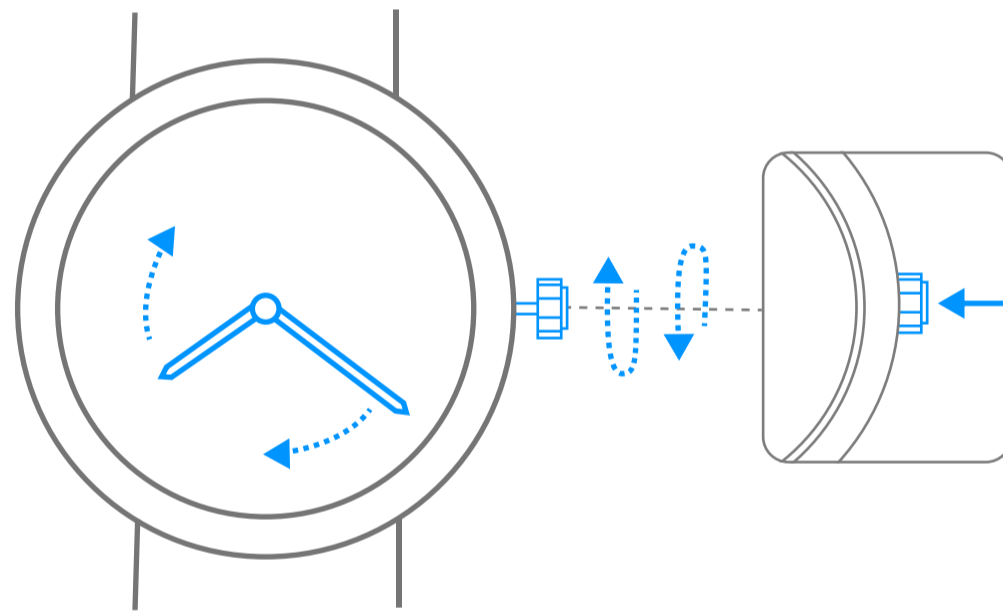

08 : 20

1.

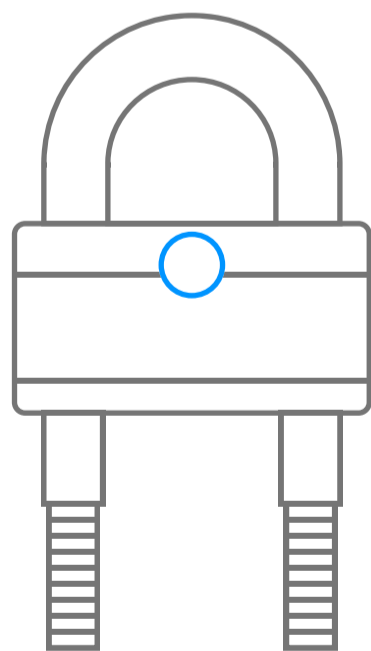

2.

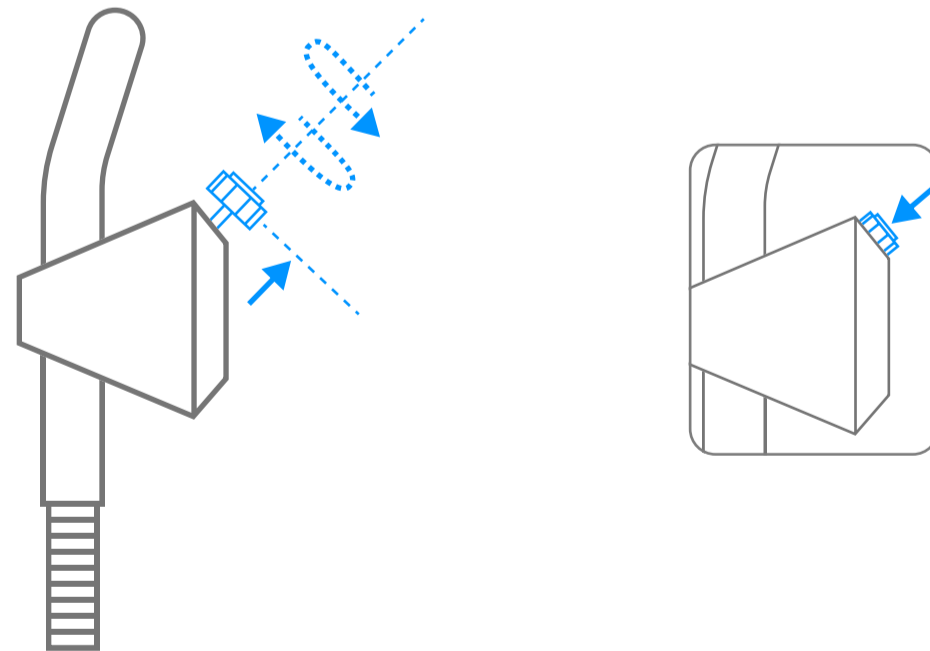

Van Cleef & Arpels

Pictogramas

00H
DE AUTONOMIA

A reserva de energia do seu relógio



Atenção: espere 30 segundos após o fim da animação para ajustar a hora

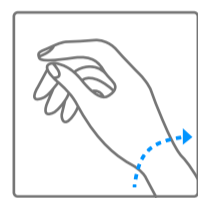

Corda automática a partir dos movimentos do pulso



Girar em sentido horário

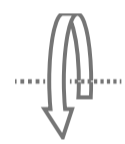

Girar em sentido anti-horário



Girar em sentido horário até encontrar resistência

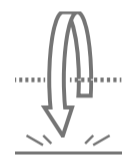

Girar em sentido anti-horário até encontrar resistência



HORA LOCAL

Hora local



SEGUNDO FUSO HORÁRIO

Hora no país selecionado



Som agudo



Som grave