

Van Cleef & Arpels

Manual-winding hour on demand retrograde movement

1. Read the time

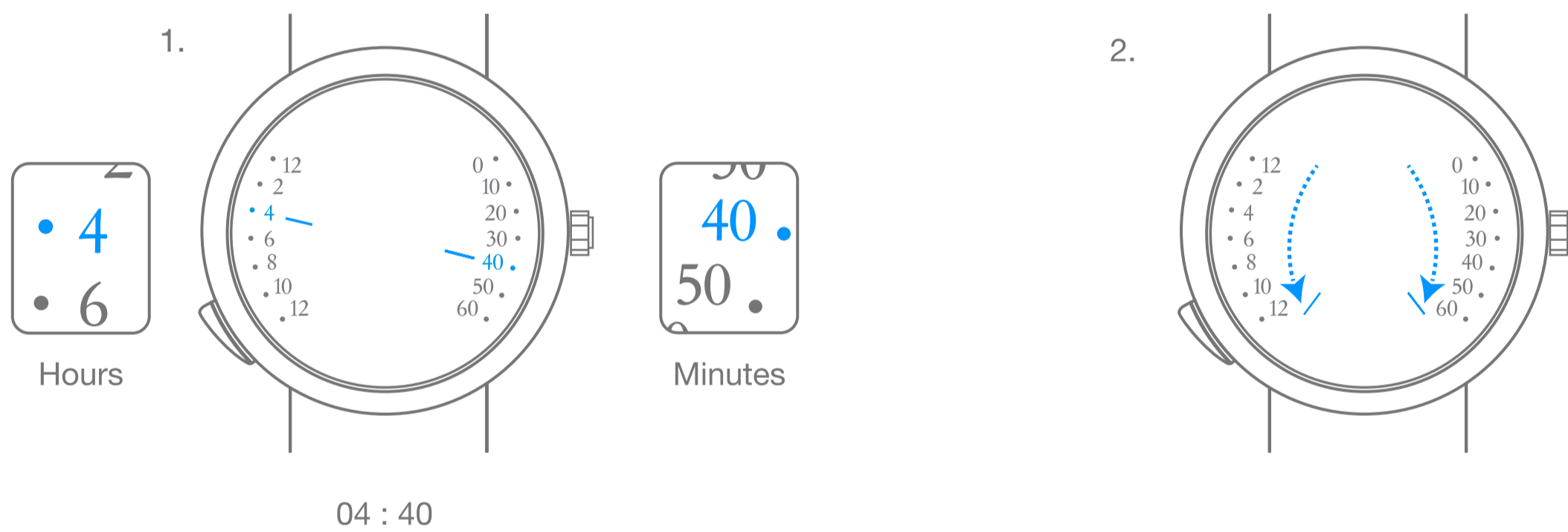
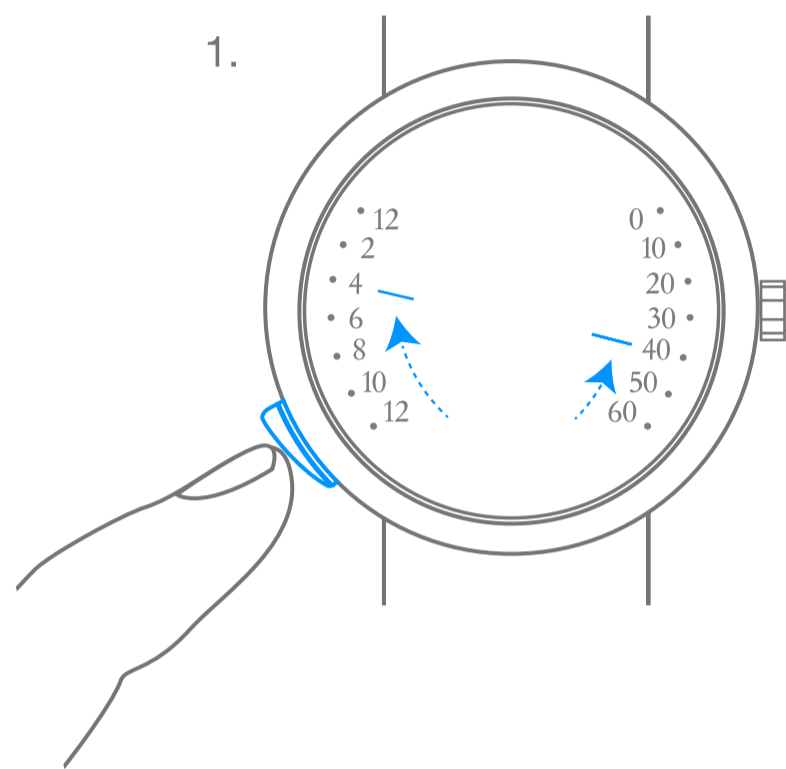

2. Wind the watch

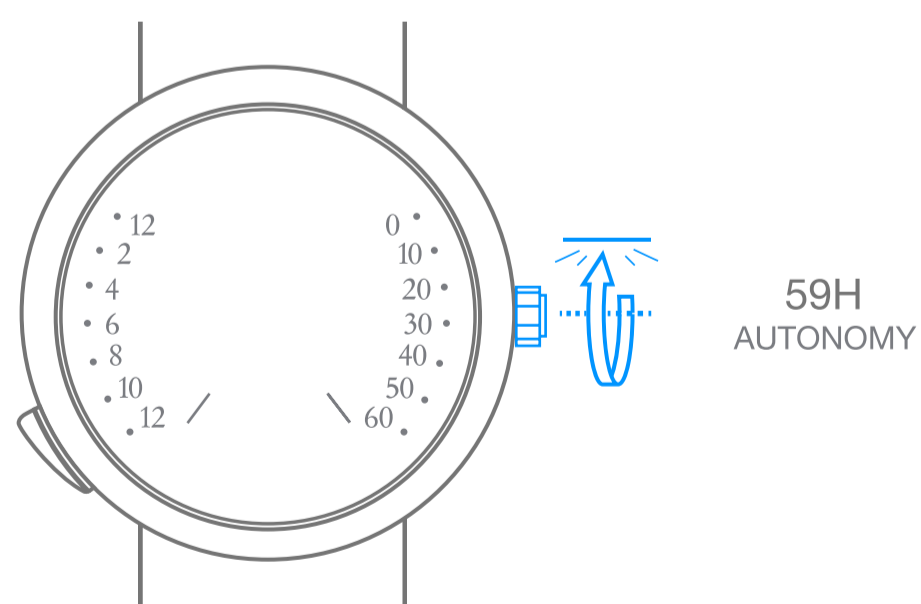

Van Cleef & Arpels

Manual-winding hour on demand retrograde movement

3. Set the time

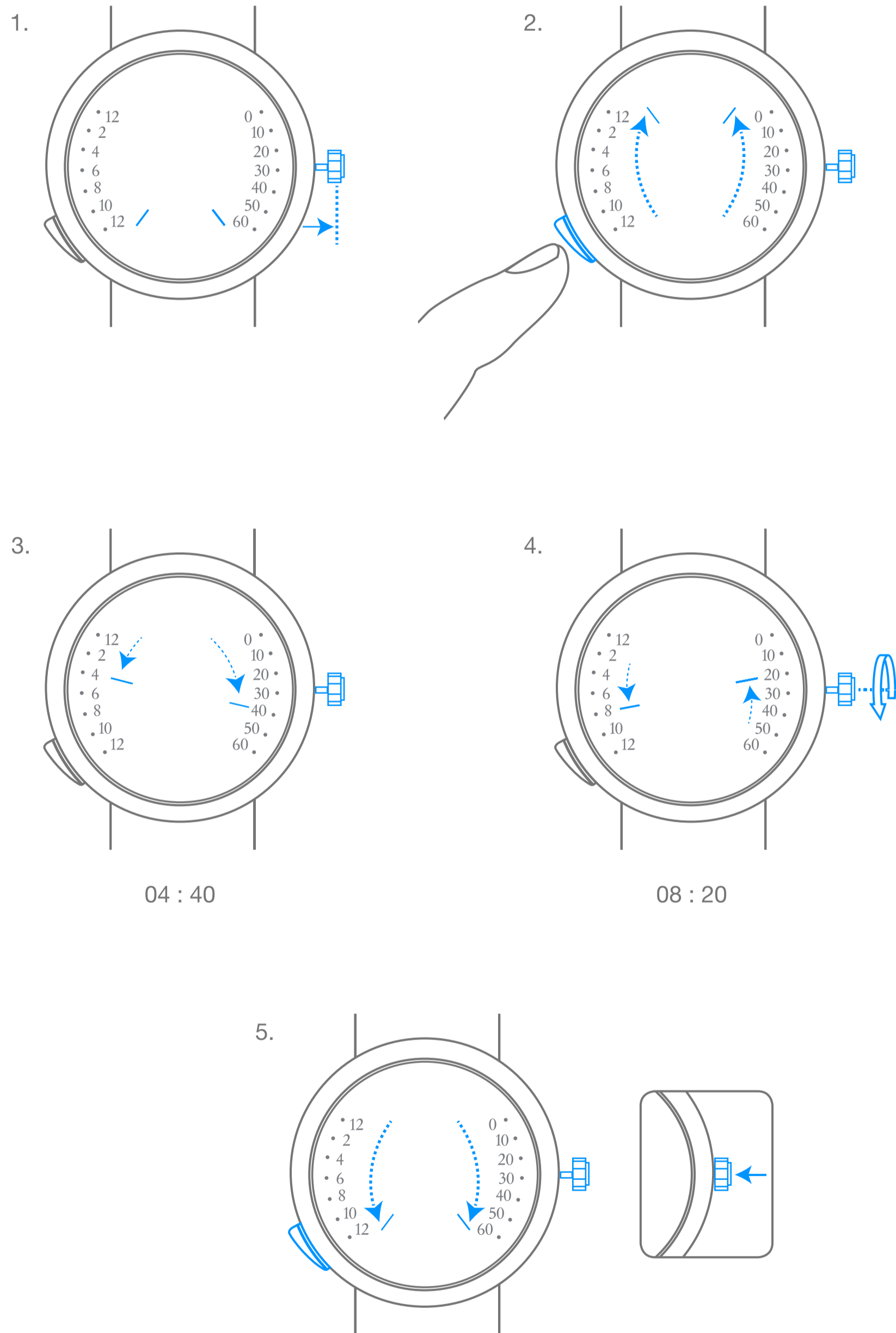

Van Cleef & Arpels

Pictograms

00h
AUTONOMY

Your watch's power reserve



Important note: wait 30 seconds after winding the watch before setting the time

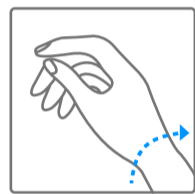

Self-winding through your wrist movement



Turning clockwise

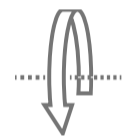

Turning counter-clockwise

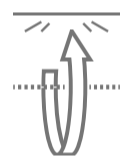

Turning clockwise until you meet resistance



Turning counter-clockwise until you meet resistance



LOCAL TIME

Local time



2nd TIME ZONE

Time in selected country



High-pitched sound



Low-pitched sound